

---

**COOLING**

**TOWER**

**CONTROLLER**

**CTH-2-6T**

*USERS GUIDE*

---

## TABLE OF CONTENTS

<b>SPECIFICATIONS</b> . . . . .	<b>3</b>
<i>Instrument</i> . . . . .	3
<i>Biocide Timer</i> . . . . .	4
<b>DESCRIPTION</b> . . . . .	<b>5</b>
<i>Default values for the CTH-2 instrument</i> . . . . .	9
<b>INSTALLATION</b> . . . . .	<b>10</b>
<i>Instrument</i> . . . . .	10
<i>Electrode</i> . . . . .	11
<i>Start Up</i> . . . . .	11
<b>CONFIGURATION</b> . . . . .	<b>12</b>
<i>Key Functions in General</i> . . . . .	12
<i>Setting real time and BIO start times.</i> . . . . .	13
<i>Configuration of Biocide Dosing</i> . . . . .	15
<i>Configuration of Operating Parameters</i> . . . . .	19
<b>OPERATION</b> . . . . .	<b>24</b>
<i>Selecting Mode of Operation.</i> . . . . .	24
<i>Inhibitor Dosing with Bleed</i> . . . . .	24
<i>Inhibitor Dosing After Bleed</i> . . . . .	24
<i>Normal / Proportional</i> . . . . .	25
<i>Flashing LED's</i> . . . . .	26
<i>Accessories</i> . . . . .	26
<b>WARRANTY</b> . . . . .	<b>27</b>

---

# SPECIFICATIONS

## *INSTRUMENT*

- Range:** 10-5000 $\mu$ S, single range
- Display:** 2 lines x 16 character LCD display
- Indicators:** 11 LED lights,  
indicate mode of operation or configuration.

### Temperature

- Compensation:** 0-100 $^{\circ}$ C. fully automatic
- Setup:** All setup values are programmed through software and stored in non-volatile memory.
- uS Electrode:** Material PVC, inline  
Cable 1/2 metre moulded into body.  
Temp. sensor encapsulated. 0-60 $^{\circ}$  C.
- Relay outputs:** 240VAC, 5A max. (*non inductive*) hard wired via 3 way terminals.

### Proportional

- Inhibitor dosing:** Inhibitor On time: 2 sec to 1min Off time: 1 to 30min
- Tower relay** After Run Time:  
5,15,30,45min and 1 to 4 hours, selected in setup program.
- Fuses:** Separate fuses for instrument and 240VAC relays.
- Power (*Instr*):** 240VAC 50Hz 7VA max.
- Dimensions:** (W)182mm x (H)110mm x (D)96mm.

---

## **BIOCIDE TIMER**

Dual biocide dosing with separate timers and relay outputs. BIO1 features 6 daily dosing times if required.

BIO2 also features 6 daily dosing times.

The 6 BIO2 timers can be programmed as 4 week timers.

**Display:** LCD display, supports week, day of week, 24H or AM/PM mode, hours and minutes. A flashing colon indicates the seconds.

Remaining dosing or lockout times are shown with an additional time display

**Lockout:** The bleed and inhibitor functions are locked out during a biocide addition cycle. A time delay continues the lockout afterwards.

**Time delay:** 5,15, 30, 45min and 1 to16 hour time delay available, selected in setup program.

**Prebleed:** If enabled, prebleed times of 5,15,30,45min 1 and 2 hours can be selected for BIO 1 and BIO 2.

---

# DESCRIPTION

The purpose-built HOFMANN CTH-2 features an easy installation and setup procedure.

All configurations are programmed with three push buttons. Text messages are shown with a 2 line LCD display. LED lights also assist in the setup and checking the operating status at any time.

The CTH-2 features two independent biocide relays. Each is configured for a start time and duration period as well as a selected day or days. The backlit LCD display shows  $\mu\text{S}$ , real time and time left for the selected bio dosing or lock out delay.

The CTH-2 tower controller continuously monitors and maintains the TDS of the recirculated water of the cooling tower and simultaneously activates the inhibitor output.

Several bleed/inhibitor-dosing configurations are available and selected through the setup program.

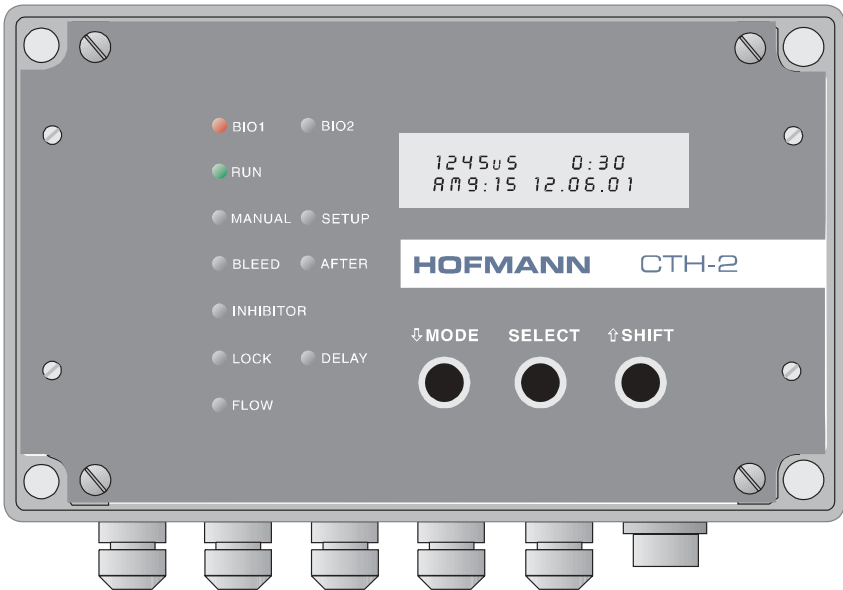

---

Timer 1 of BIO 1 is always activated by default and cannot be disabled. This insures that there is at least one biocide dosing each day. The remaining 5 BIO1 and 6 BIO2 timers are “transparent”. They only show on the LCD display if activated.

The bleed valve and inhibitor output are locked out for the duration of a biocide cycle to allow enough time for the biocide chemical to react with the tower water. A further enhancement is possible with a second timer keeping the lockout on for a set time delay allowing the injected biocide to take full effect before further water bleeds take place.

BLEED and INHIBITOR dosing are therefore suspended (*LOCKOUT*) during any of the BIO1 or 2 dosing cycles. This is indicated with the “LOCK” LED. This lockout continuous for the programmed DELAY time. (*Shown with the “DELAY” LED*)

In ‘PREBLEED’ the CTH-2-6T suspends the called biocide dosing and performs a bleed first. Prebleed times are set in the configuration setup. The duration time is shortened if the  $\mu\text{S}$  falls below the set point in a prebleed. The programmed biocide dosing starts once a prebleed is completed.

The INHIBITOR dosing can be configured in several ways. First option is “NORMAL” to simply dose inhibitor simultaneous during the bleed cycle. Selecting “PROPORTIONAL” greatly helps to control the amount of inhibitor chemical used. The pump only doses for the programmed ON time during a BLEED cycle.

Inhibitor dosing is performed completely separate from the bleed if INDEPENDENT” is selected.

The third option for proportional dosing is “EXTERNAL” The inhibitor pump is triggered with an external pulse input. The inhibitor dosing ratio can be very exact if a water meter measuring the bleed flow is used and the proportional ON and OFF times are calculated

In ‘AFTER BLEED’ the CTH-2-6T only activates the bleed (*if called*) and monitors the bleed time. At completion of the bleed cycle the inhibitor is turned on for an equal time. Selecting proportional inhibitor gives an

---

operator the added flexibility to reduce the total amount of inhibitor injected.

Should a biocide cycle occur during an after bleed operation, bleed and/or inhibitor dosing are suspended and continued after any lock out from the bio cycle.

The tower relay switches on with each bio cycle and remains active throughout the dosing, delay and the selected After Run Time. This feature if utilised ensures that the tower water always circulates during a biocide dosing.

A flow switch can be connected to an input terminal that will switch off bleed and inhibitor dosing in the event of no water flow through the system. N/O or N/C operation is selected in 'DO SETUP'

The software of the CTH-2-6T controller is basically constructed in three parts RUN - MANUAL - SETUP. The MODE key toggles between these modes indicated with three LED's. Pressing the SELECT key enables the appropriate mode.

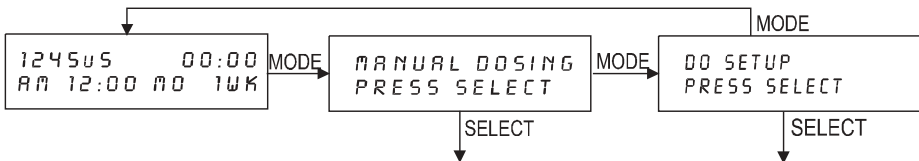

---

## RUN

This state is the basic running mode of the instrument indicated with the green 'RUN' led. Conductivity, time of day, week period and any remaining time for BIO dosing or lockout is shown. Pressing the 'SHIFT' key show water temperature, electrode connection and battery status. The display returns to RUN after 5 minutes if left in the status window.



*Pressing 'SHIFT' shows you water temperature and battery condition. Press 'SHIFT' again to return to the first display.*

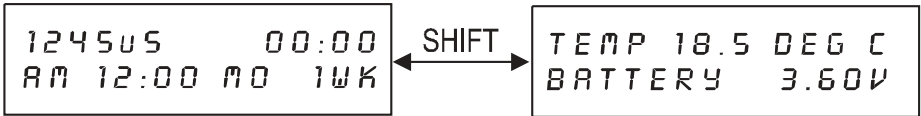

## MANUAL DOSING

This mode enables the operator to quickly switch any output relays on and off manually. Press 'SELECT' to enable manual dosing. Pressing 'SHIFT' toggles through BIO1, BIO2, BLEED and INHIBITOR. Now press 'SELECT' to switch the relay on or off. If the instrument is left in any manual mode for more than 5 minutes it automatically returns to 'RUN' mode, operating with the previously set parameters.



*Press 'SELECT' to enable manual dosing. Press 'SHIFT' to select the BIO1, BIO2, BLEED or INHIBITOR relay then press 'SELECT' to switch on and off.*

## DO SETUP

This section deals with all the variables that must be set for proper calibration and operation of the CTH-2-6T instrument. All set parameters can be viewed by scrolling through the values in 'SHOW CONFIGURATIONS' Pressing 'SELECT' advances to the next figure, pressing 'SHIFT' in a particular section moves directly to the appropriate configuration menu.



---

## Default values for the CTH-2 instrument

The CTH-2-6T is shipped with default values programmed in the non-volatile memory. *(These values are always retained in the instrument even if the power is switched off and the battery loses power.)*

BIO1 T1 = AM9:00 15MIN, BIO1 T2 - T6 = DISABLED

BIO1 LOCKOUT = 2 HOURS

BIO2 = DISABLED

NO PREBLEED

INHIBITOR with BLEED, INHIBITOR dosing NORMAL *(not proportional)*

CALIBRATION factor = 1.00

SET POINT = 1500 $\mu$ S

TOWER RELAY is set for 30 minutes operation

Of course all values can be customized through the configuration setup. *(Look up CONFIGURATION)* Entered values are also held in a non-volatile memory and are not lost through power- or battery failure.



If you are viewing a parameter in 'SHOW CONFIGURATION' and want to change this value press 'SHIFT' to take you directly to the corresponding configuration setup.

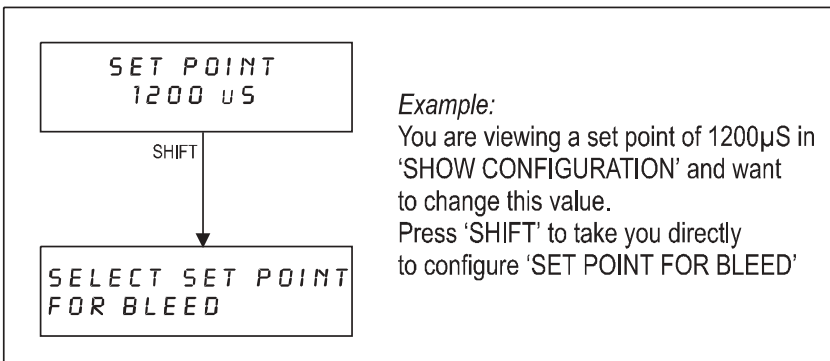

Customised values entered for biocide, calibration, set point (etc) are never lost through power failure or faulty battery

# INSTALLATION

## Instrument

The instrument is fastened to a wall or subpanel by means of four screws. The mounting holes are revealed after removal of the front cover.

Terminals for BIO1, BIO2, BLEED, INHIBITOR and TOWER RELAY provide earth, neutral and switched 240VAC active for metering pumps, solenoid valves or other devices requiring 240V.

The bleed valve output already has interference filtering and no additional components are needed for electrical protection of the instrument

It is imperative that all connections are wired through the cable glands and the transparent lid is always tight to ensure that no corrosive liquids inadvertently splash into the instrument.

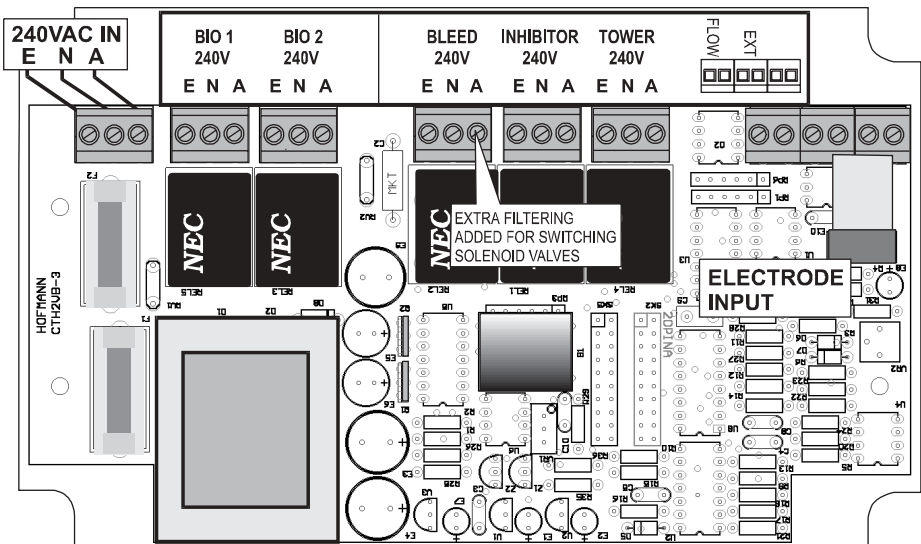

The Set point relay terminals connect to earth, neutral and switched active 240V. (240VAC is supplied to these terminals when activated by the set point.)

---

## Electrode

The cell is mounted in line into a 3/4" BSP Tee. If the electrode is installed into a PVC T-joiner extra care must be taken to insure that the 2 stainless steel electrodes protrude far enough into the body to be immersed into the flow of water through the pipe.

The T-piece used to install the electrode must be PVC to ensure that no short circuit between the stainless steel electrode and pipefitting occurs. A conduction leakage may also affect the accuracy of the instrument reading if a metal T-piece is used.

Insert the conductivity cell into a plastic 3/4" BSP tee that is connected into a sample line and plug into the 4-pin socket on the instrument.

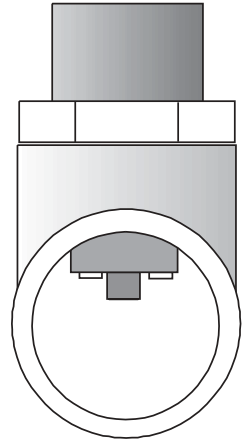

*When inserting the electrode into the Tee be certain that the metal sensors protrude into the in line section of the Tee piece to ensure the water flows across the two sensors.*

The electrode plugs into the 4-pin socket situated on the underside of the instrument. Never cut the cable or rejoin the 4 wires in order to shorten or lengthen the cable, as this will result in unreliable and inferior performance. Always reconnect the whole length of the cable to the 4-pin plug. A longer cable up to 20 meters can be supplied on request.



*Ensure that you can isolate the water flow in the sample line to enable the removal of the conductivity cell for periodic cleaning.*

## Start Up

Switch on the main power and water flow through the sample line. Select Manual Inhibitor, prime the inhibitor pump and fill the tubing until all air is evacuated. Set the pump settings to the correct dosing requirements. Repeat the above procedure with the biocide pumps.

---

# CONFIGURATION

## Key Functions in General

### MODE

This key has two basic functions. The first is to move through the different modes (*LED*) or menu's (*LCD display*) to select manual dosing or changing configurations.

If you do not want to save values just entered press the "MODE" key to discard these and take you back to the particular configuration window. Pressing "MODE" again steps to the next window.

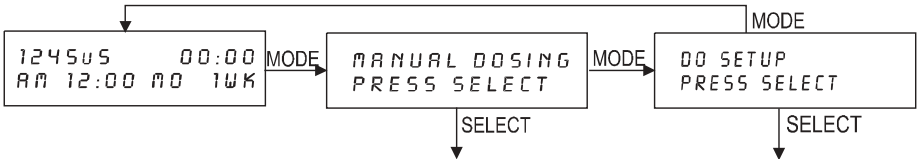

### SELECT

Press this key to accept and save values or numbers entered into the non-volatile memory to change the program to your particular setup.

In manual mode the chosen output switches on and off.

In 'SHOW CONFIGURATIONS' pressing this key advances to the next window.



*No values entered (time or numbers) are saved into memory or used until the "SELECT" key is pressed.*

### SHIFT

Press this key to toggle any options available in a particular window.

In 'RUN' mode battery status, electrode connection and sensor temperature are displayed.

This key also is used for "short cuts". Pressing MODE twice and then SHIFT takes you directly to the "SHOW CONFIGURATIONS"

If you want to change any values whilst checking them in this mode press SHIFT to move directly to this setup.

---

**Setting real time and BIO start times.**

A battery keeps the timer clock running continuously even if no power is applied to the instrument. The time may be lost however if the battery voltage is very low due to long storage of the CTH-2 or if no power was applied for extended periods.

The time can be set quickly through the setup program. Press 'MODE' two times to take you to the setup menu:

```
DO SETUP
PRESS SELECT
```

Press SELECT

```
CONFIGURE TIME
AND TIME MODE
```

Press SELECT

```
ENTER TIME
FOR AM/PM MODE
```

← SHIFT →

```
ENTER TIME
FOR 24 H MODE
```

Choose the desired mode and press SELECT

```
SET TIME ?
AM 12:00
```

SHIFT changes the values, MODE moves the cursor from left to right, Press SELECT to accept the set time. *(time is not yet saved at this point)*

```
SET DAY: MTWTFSS
      =T-----
```

SHIFT selects the week day, MODE moves the cursor from left to right

---

SELECT accepts the week day. (*only one day can be entered*)

You are now asked to save the entered time and week day. Pressing SELECT will save the values into memory. Pressing MODE will discard the values and the program uses the previous time.

MODE :  
discard time

```
SAVE TIME ?  
PM 02:14 FRI
```

SELECT:  
save time

You are now asked to set BIOCIDE 1 TIME1.

```
CONFIGURE  
BIOCIDE 1 TIME 1
```

Press SELECT if you want to configure the biocide 1 cycle. Press MODE to advance to BIO1 TIME2, BIO1 TIME3 and BIO2. To return to RUN directly, press SHIFT.



*Times and days entered are not accepted by the program until you are prompted to save them by pressing the SELECT key. You can always abort by pressing the MODE key.*

One day to all days of the week or any combination of days can be programmed for the BIO1 and BIO2 cycle. BIO2 also runs in a 4-week mode making a one day a month dosing possible. BIO2 can be disabled if only one BIO dosing is required.

No program changes are made as long as you do not press SELECT when asked to save values. This always allows you to 'escape' from a configuration setup without changing values.

The CTH-2-6T if left in any 'SETUP' position, even in the middle of changing the time reverts to 'RUN' after 5 minutes without saving any configuration changes made. The instrument therefore cannot be left 'disabled' or dosing pumps left running continuously.



*The CTH-2-6T returns to 'RUN' after 5 minutes if left anywhere in manual or configuration mode, without saving just entered values.*

---

## Configuration of Biocide Dosing.

### Setting BIOCID1 dosing, duration & lockout times.

BIOCID1 is a weekly timer. 6 DOSING times and individually set DURATIONS can be set for each day. Duration of each timer is programmable from 1 to 120 minutes. T1, T2, T3, T4, T5 and T6 can be set individually for any combination of weekdays. However the selected DELAY time applies to all 6 timers. T2 to T6 are disabled with the SHIFT key when prompted in the initial setup window.

Only T1 is enabled by default. When T1 is programmed you are prompted to enable/disable T2. If T2 is enabled and configured you are prompted for T3 and so on. When disabling a timer it disappears and will not show either when scrolling through the setup menu with the MODE key or looking up "SHOW CONFIGURATION"

This feature greatly helps the efficiency of operation as you only scroll through the active timer configurations.

The easiest way to escape if a wrong entry is made during a configuration is to press SELECT repeatedly until asked to save. Now press MODE to return without saving and start again.

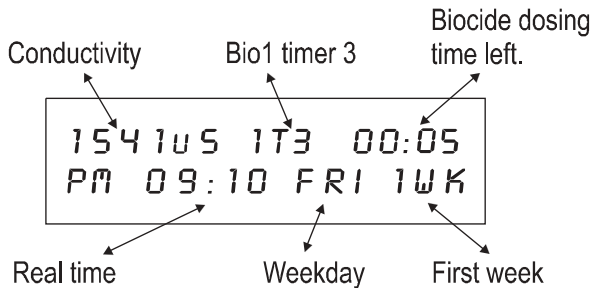

The timers are identified in the display window during a biocide cycle. The remaining biodosing time is displayed on the top line, right side. Which timer calls the biodosing is indicated as 1T1, 1T2, 1T3, 1T4, 1T5 or 1T6.

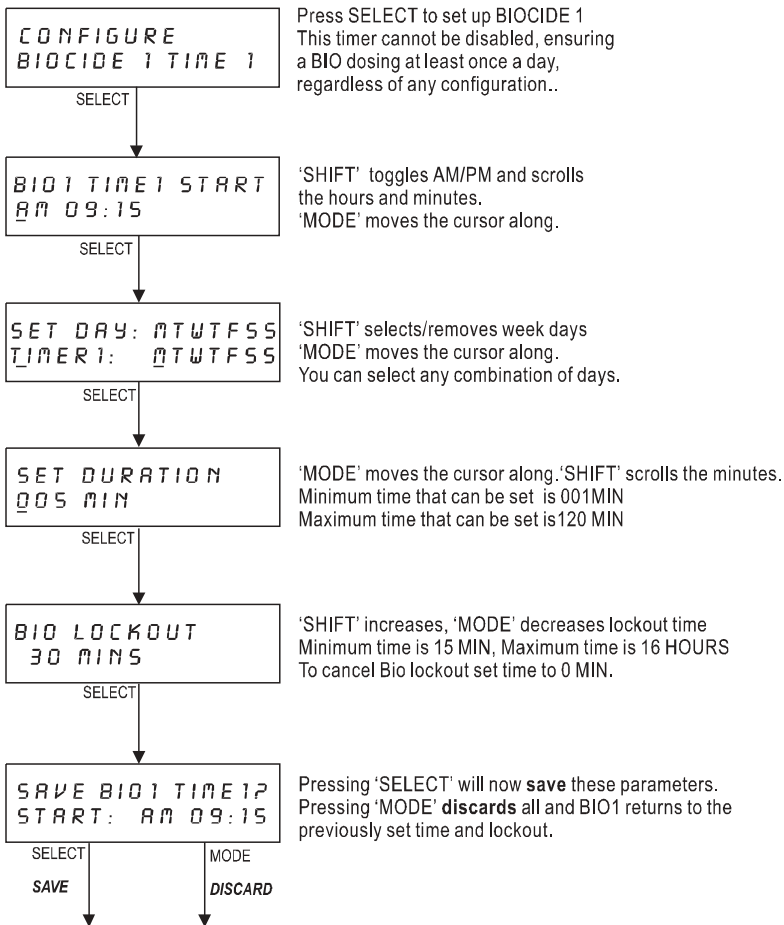

## BIOCIDE 2

BIOCIDE 2 is a 4 week timer. 6 DOSING times and individually set DURATIONS can be set for each day. Duration of each timer is programmable from 1 to 120 minutes. T1, T2, T3, T4, T5 and T6 can be set individually for any combination of weekdays or day in any of the 4 weeks. The selected DELAY time applies to all 6 timers. T1 to T6 are disabled with the SHIFT key when prompted in the initial setup window.

When T1 enabled and programmed you are prompted to enable/disable T2. If T2 is enabled and configured you are prompted for T3 and so on.



When disabling a timer it disappears and will not show either when scrolling through the setup menu with the MODE key or looking up “SHOW CONFIGURATION”

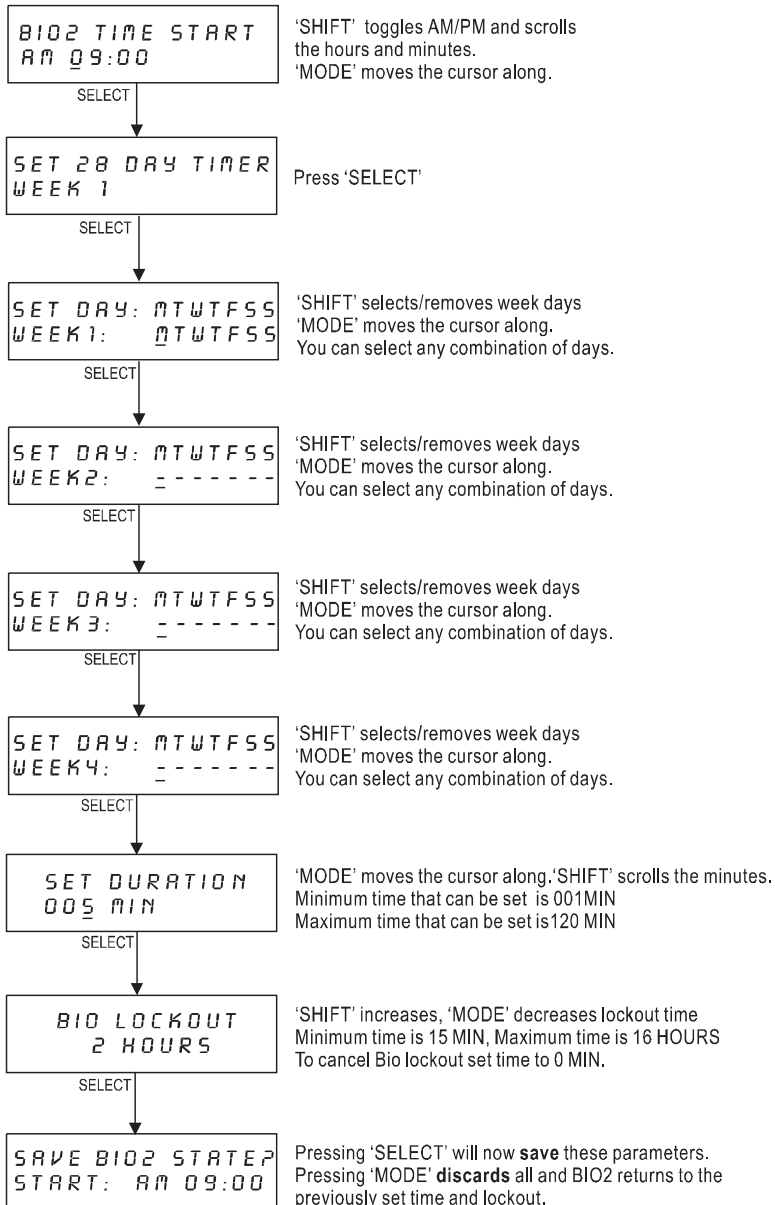

---

This feature greatly helps the efficiency of operation as you only scroll through the active timer configurations.

The easiest way to escape if a wrong entry is made during a configuration is to press SELECT repeatedly until asked to save. Now press MODE to return without saving and start again.

The timers are identified in the display window during a biocide cycle. The remaining biodosing time is displayed on the top line, right side. Which timer calls the biodosing is indicated as 2T1, 2T2, 2T3, 2T4, 2T5 or 2T6. BIO1 & BIO2 can be configured to dose at the same time of the day if required.

### **PREBLEED and BIOCIDES dosing**

Prebleed if enabled always precedes a biocide dosing by the programmed prebleed time. The biodosing start time has to be configured earlier by the prebleed time

If the biodosing has to be at an exact time of day you have to consider the prebleed time and program the biostart time earlier.

Example:

BIO1 start AM 9.00 PREBLEED set at 30 minutes.

Bio1 will start prebleed at AM 9.00 for 30 minutes. At AM 9.30 biocide1 starts dosing.

If BIO1 & BIO2 start the same time, with prebleed enabled, only program PREBLEED1 and start BIO2 this amount of time later.

Example:

BIO1 start AM 9.00 duration 15minutes, BIO2 start AM 9.15 PREBLEED set at 15minutes.

Bio1 will start prebleed at AM 9.00 for 15 minutes.

At AM 9.15 biocide 1 and biocide 2 start dosing.

---

## Configurations of Operating Parameters.

### CONDUCTIVITY CALIBRATION

Ensure that the instrument shows a steady  $\mu\text{S}$  reading and you are certain of the actual conductivity of the water or buffer solution. Go to the calibration setup and enter the conductivity value.

The next window simply reminds you to prepare the electrode in a buffer solution. You can also use a simulator 'plug' (*optional accessory*) or a conductivity simulator. When you are certain that a known value is connected move to the next window.



Press 'SHIFT' to scroll the digits or 'MODE' to move across the digits. After entering the correct value press 'SELECT' to save the calibration.

### SELECT SET POINT FOR BLEED

Here you enter the desired set point for the CTH-2-6T to keep the conductivity of the tower water.

Press 'SHIFT' to scroll the digits or 'MODE' to move across the digits. After entering the correct value press 'SELECT' to save the calibration.

### INHIBITOR 'NORMAL/PROPORTIONAL'

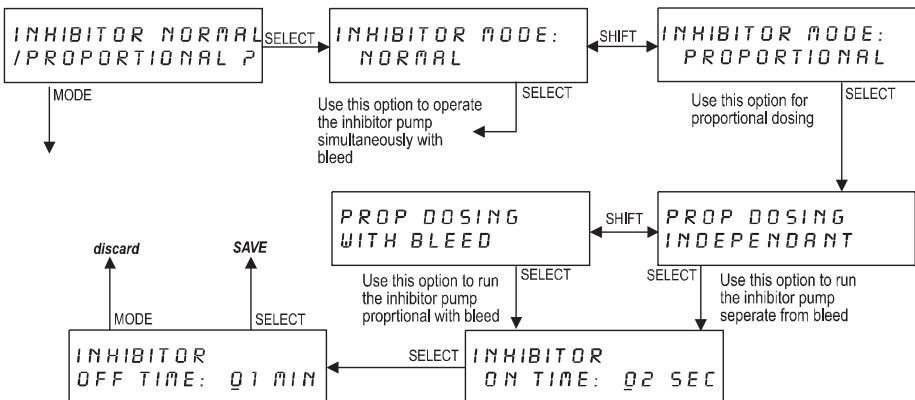

## INHIBITOR DOSING WITH EXTERNAL TRIGGER

Connecting a water meter to the 'EXT' terminal (*See connections*) enables an inhibitor dosing directly proportional to the water bleed. Only the ON time (*2sec to 1 min*) is programmed. Each pulse from a water meter runs the pump for the set ON time. Pulses are stored in memory (*max 50*) if the input pulses from the water meter arrive at shorter time intervals than the pump can execute the inhibitor dosing.

Inhibitor dosing with bleed must be selected first if you want to use external trigger.

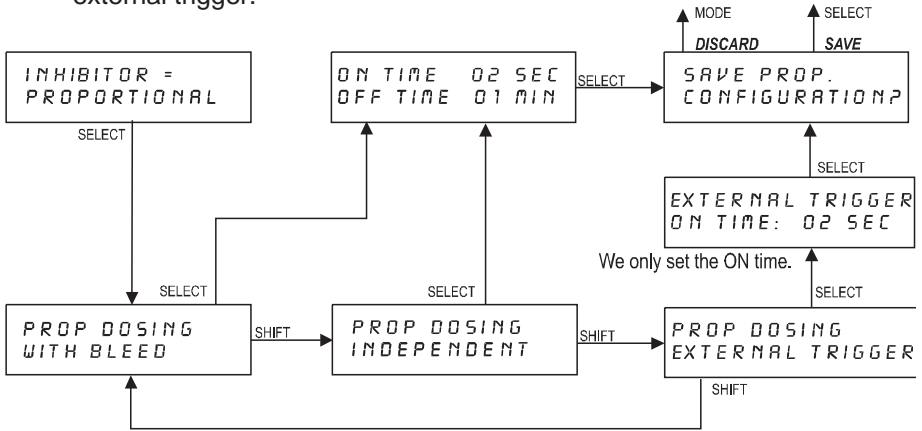

## CONFIGURE PREBLEED

If prebleed for either BIO1 or BIO2 is enabled, a prebleed takes place prior to bio dosing and lockout. The prebleed starts at the programmed BIO time. The duration time of the prebleed can be configured after prebleed for BIO1 or BIO2 is enabled. A prebleed time of 5, 15, 30, 45 minutes or 1 hour can be selected. A prebleed cycle is indicated by "PREBLEED" appearing in the top right corner of the LCD display.

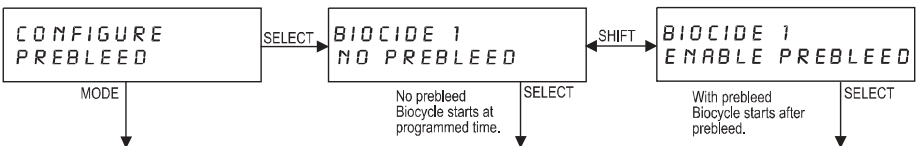

---

## CONFIGURE AFTERBLEED

The bleed time is counted and stored in afterbleed mode. After the bleed has finished the inhibitor pump is then switched on for the same length of time. If a biodosing interrupts either bleed (*counting time*) or inhibitor dosing (*counting down*) either are suspended and any remaining time is left in the counter for execution after the lockout has finished.

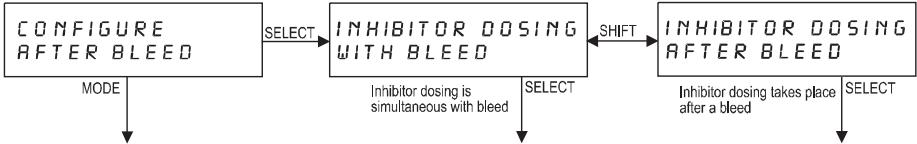

Bleed times are added to the counter if a new bleed is called before the previous inhibitor dosing is finished. A maximum of 1 hour is held in the counter.

Proportional dosing can be used in the afterbleed mode to reduce the amount of inhibitor pumped into the water.

The 'after' LED flashes if counting the bleed time, stays on if timing out the inhibitor dosing. A flashing 'after' LED during a biocycle or lockout indicates some time left for inhibitor dosing.

## CONFIGURE FLOW SWITCH

Normally open is used for flow switches that open a contact with flow, normally closed is used for flow switches that close a contact with flow. Make sure that normally open is configured if no flow switch is used in the system.

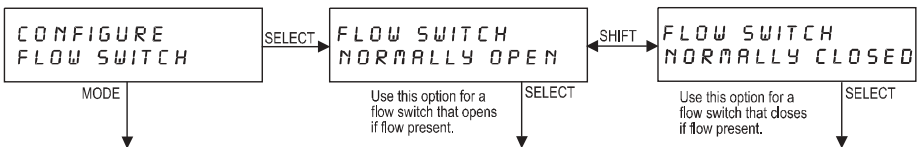

## CONFIGURE TOWER SETUP

The “tower relay” activates on every BIO cycle and remains switched on during a BIO cycle, any programmed delay lockout and “TOWER RELAY ON” time. The lock LED pulses during this period. Bleed and inhibitor dosing also can take place until the “TOWER RELAY” switches off and the cooling tower shuts down.

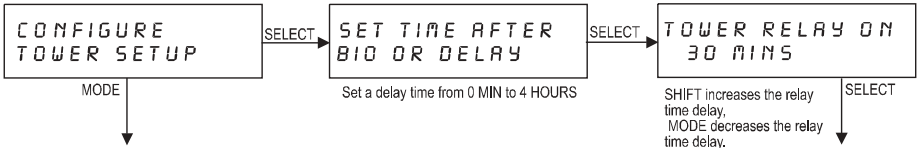

## SHOW CONFIGURATIONS

Pressing the ‘SELECT’ key toggles through all the configurations set by the operator. If you want to change a setting displayed in a window press the ‘SHIFT’ key to take you directly to this particular setup menu to change the parameters.

To check the configured parameters without toggling through all the different configuration windows press MODE twice. The ‘SETUP’ LED is now lit up. Now press ‘SHIFT’ which takes you directly to the “SHOW CONFIGURATIONS”

If you are looking at a particular setup in ‘SHOW CONFIGURATIONS’ and want to exit simply press ‘SHIFT’ twice to return to ‘RUN’ mode.

This is a save way of checking the set parameters without the danger of accidentally changing them.

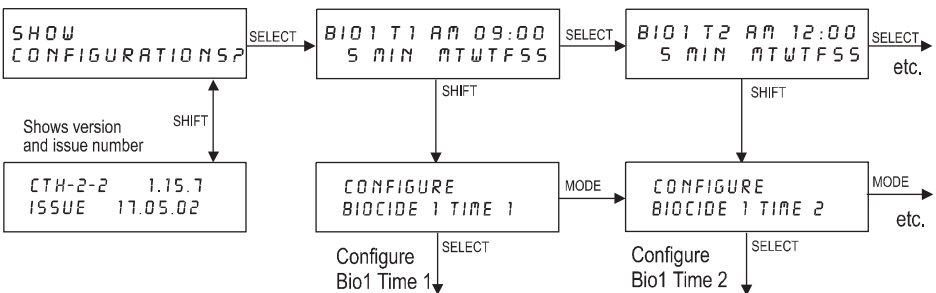

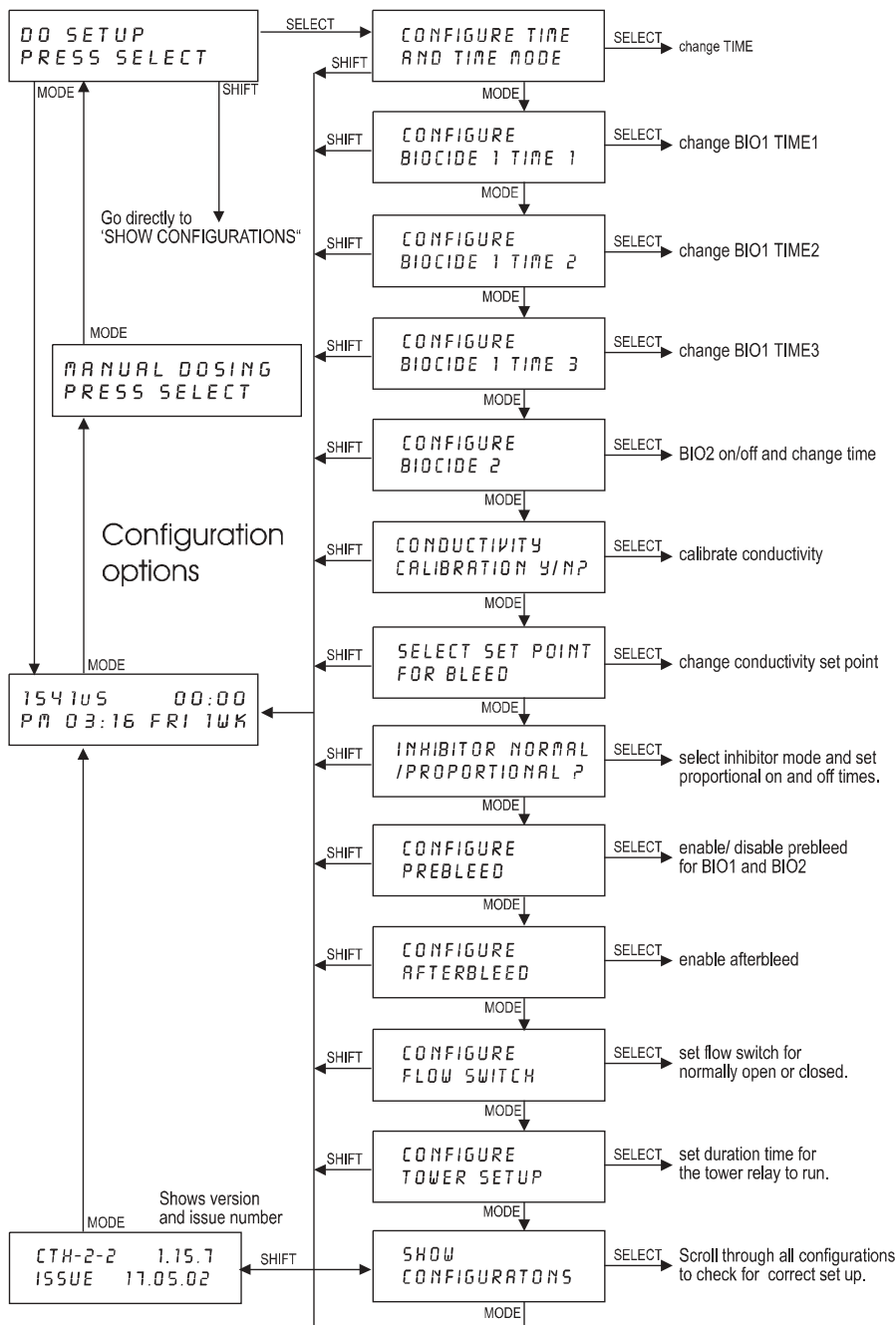

---

# OPERATION

## *Selecting Mode of Operation.*

### **MANUAL BIO1 & BIO2**

Switches biocide pumps manually for priming, checking or manually dosing biocide to the cooling tower water.

### **MANUAL INHIBITOR**

Switches the inhibitor pump manually for priming, checking or manually dosing inhibitor to the cooling tower water.

### **MANUAL BLEED**

Switches the bleed valve manually for checking bleed flow or manually bleeding the cooling tower.



*All manual functions are terminated after 5 minutes and the CTH-2-6T returns to "RUN" mode.*

### ***Inhibitor Dosing with Bleed***

The  $\mu\text{S}$  of the water is measured and displayed in the top left corner of the LCD display. If the  $\mu\text{S}$  value exceeds the set point the bleed valve and inhibitor pumps are switched on together. The inhibitor and bleed LED light up. They turn off as soon as the desired  $\mu\text{S}$  configured with the SET POINT control is achieved.

A dead band of 20  $\mu\text{S}$  is build into the program. The CTH-2-6T switches on the outputs if the conductivity falls 20  $\mu\text{S}$  below the set point. They are switched off exactly at the configured set point.

The duration of the biocide cycle will lock out the bleed/inhibitor operation. This is indicated by the "LOCK OUT" LED and the inhibitor/bleed LED flashing. Normal operation returns after a biocide cycle and any configured bio lockout delay time. (DELAY LED)

### ***Inhibitor Dosing after Bleed***

The bleed valve is opened first until the desired conductivity is reached. The 'AFTER BLEED' LED flashes to indicate that the inhibitor pump will be operated after the bleed. The time of the activated bleed valve is



---

counted into an internal memory and the inhibitor pump is operated for the same time interval on termination of the bleed cycle. The 'AFTER BLEED' LED changes to steady for the period of the inhibitor pump operation.

If the biocide cycle interrupts the after bleed operation, 'counting time' of the bleed valve or 'timing out' of the inhibitor pump is suspended. Accumulated times already in memory are kept until the biocide cycle and the lock out delay are finished. Normal operation continues and time left in the memory is included in the running of either bleed valve or inhibitor pump.

### ***Normal / Proportional***

The inhibitor pump runs simultaneous with the bleed valve if 'NORMAL' is selected. 'PROPORTIONAL' allows you to run the inhibitor pump in an on/off cycle. These times are programmable if PROPORTIONAL is selected. ON time is from 2 to 60 seconds. OFF time (*time interval between pulses*) is from 1 to 30 minutes.

Select INDEPENDENT if you want the inhibitor to dose at a set rate regardless of any bleed taking place. INDEPENDENT is only available if 'Inhibitor Dosing with Bleed' is selected.

Select EXTERNAL if you want to use a flow meter to control the inhibitor pump. In this mode only the ON time is set. EXTERNAL is only available if 'Inhibitor Dosing with Bleed' is selected.

The mode of proportional dosing selected is indicated on the top line of the LCD display with either PwB (***Proportional With Bleed***) IND (***IN*dependent**) or EXT (***EX*Ternal**).

---

### **Flashing LED's**

A flashing LED on the CTH-2 (*3mm round lights*) indicates that a process is called but the appropriate output relay is prevented or delayed from switching.

### **BIO1 and BIO2 LED's**

The bleed valve opens prior to a biocycle if configured for prebleed. This happens at the programmed BIO start time. The BIO1 or BIO2 LED flash indicating which BIO is ready to dose once prebleed is finished. "PREBLEED" also appears in the status window.

### **BLEED and INHIBITOR LED's**

These LED's flash if bleed or inhibitor are called to operate but a biocycle or programmed delay time lock out one or both relays.

### **AFTER LED**

A flashing LED if in a bleed mode indicates that the bleed time is counted and stored in memory.

A flashing LED in a lockout situation indicates that time is left in the bleed counter and inhibitor dosing will take place once the lockout is terminated.

### **LOCK LED**

A flashing LOCK LED (1/2 sec on, 5 sec off) indicates a timing out of the 'TOWER AFTER DELAY'

## **Accessories**

### **Simulator plug**

This device greatly assists in trouble shooting problems. The plug has an encapsulated temperature sensor and a simulated 1000 $\mu$ S.

Simply plug into the electrode input in place of the electrode to assess the source of a potential problem.

### **Isolated 4-20mA expansion board.**

A 4-20mA plug-in board is available to instantly provide a fully isolated 4-20mA current output. This board can be installed in seconds even on already installed equipment. Wiring is via a two way terminal. 20mA can be scaled between 2500 and 5000 $\mu$ S.

---

## WARRANTY

We, **HOFMANN ELECTRONICS**, guarantee this unit against defects due to faulty manufacture or breakdown of components for a period of twelve month from the date of purchase, subject to the following provisions:

- The guarantee will cover original failure of parts and natural defects due to manufacturing causes. Otherwise repair charges are to be to the owners cost.
- The warranty does not cover any carriage costs.

The warranty is void if:

- The instrument is damaged due to rough handling or transport after purchase.
- The article has not been used in accordance with the operating instructions.
- Any parts in the instrument have been changed or have been altered in any way.
- The serial number is removed or defaced.

All other warranties and conditions, express or implied, are void.

---

◦ CTH-2 -6T

**SERIAL No.**

---

Due to a continuing effort to improve the product the manufacturer reserves the right to change or alter the product without notices.

---

**NOTES:**